

FISCHBEIN®

Model 400 PRO™

Plain Sew

Fischbein Model 400 PRO™

The Fischbein Model 400 PRO™ is an affordable, entry level sew system that provides a cost-effective solution for the most demanding production environments. Operating at adjustable speeds up to 55 linear feet per minute, this heavy-duty system is easy to operate and delivers quality performance at speeds twice as fast as handheld portable bag closers.



EVERYTHING IN BAGGING EQUIPMENT™



Fischbein® Model 400 PRO™

Plain Sew

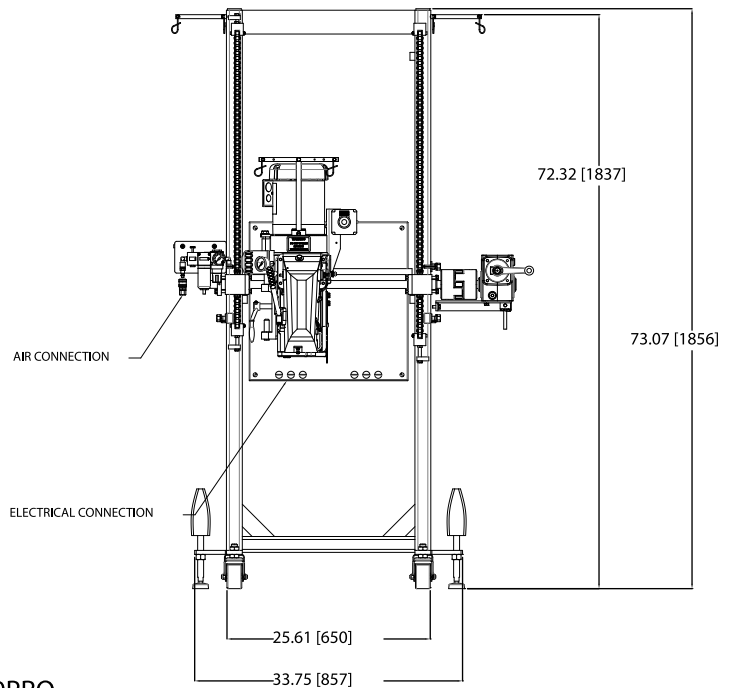
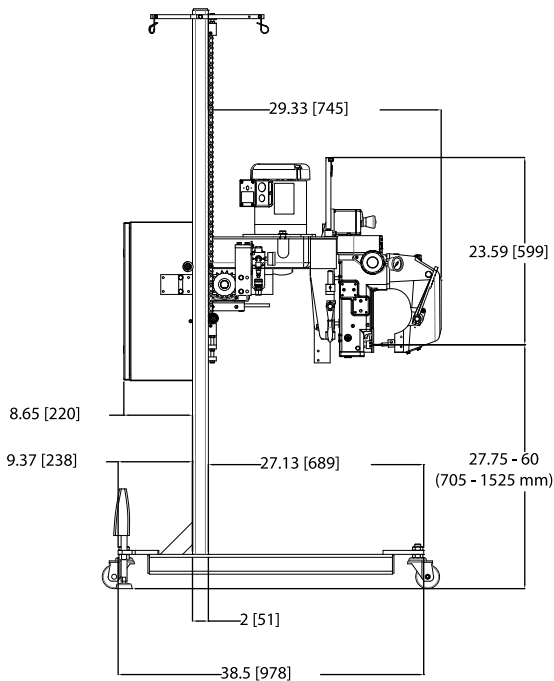

400PRO

FEATURES

BAG TYPES

Closes a variety of pillow style or gusseted bags, including multi-wall paper, laminated and non-laminated woven polypropylene, and jute.

EMPRESS 100 SEWING HEAD

With its self-lubricating system, the Empress 100 delivers trouble-free, smooth performance with low vibration. Operating speed is adjustable from 35 to 55 linear feet per minute.

COMPACT PEDESTAL DESIGN

Mobile, adjustable-height pedestal with casters and leveling jackscrews can be easily integrated into any manual bagging line.

SWING FEATURE

Fischbein's exclusive sewing-head swing feature makes threading the 400 PRO™ a snap, and provides full access for cleaning and easy head removal.

OPTIONS

- Air Thread Pusher - Requires 1 cfm @ 90 PSI
- 575 VAC
- Special export crating

SPECIFICATIONS

- Dimensions: L 36 in (91 cm), D 41 in (104 cm), H 73 in (185 cm)
- Speed: Up to 55 linear feet per minute
- Electric (NEMA 12): 230/380/460 VAC, 3 PH, 50/60 Hz
- Air: No air unless using air thread pusher

BAGS

- Bag Types: Multi-wall paper, laminated and non-laminated woven polypropylene open mouth bags
- Bag Thickness: Maximum 12 mils
- Free Bag Top: Minimum 6 in (15.2 cm)

APPLICATIONS

- Fertilizers/Minerals
- Cat Litter
- Feed Additives
- Bakery Mixes
- Chemicals
- Pet Food
- Agricultural Seed
- Powdered Dairy Products

704-871-1159

**HAMER
FISCHBEIN®**

A DURAVANT COMPANY

Specifications are subject to change without notice.

