

FISCHBEIN®

Model 400 THP™

High Performance Tape Sew

Fischbein Model 400 THP™

The Fischbein Model 400 THP™ is a high-performance tape sew system designed for bagging applications up to 75 linear feet per minute. It is used with multi-wall paper and laminated woven polypropylene open mouth bags to create an attractive crepe tape sewn bag closure. The Model 400 THP™ automatically trims the top of the bag, applies the tape, sews the bag closed and lastly cuts the crepe tape and thread at the completion of each sewing cycle.



EVERYTHING IN BAGGING EQUIPMENT™



Fischbein® Model 400 THP™

High Performance Tape Sew

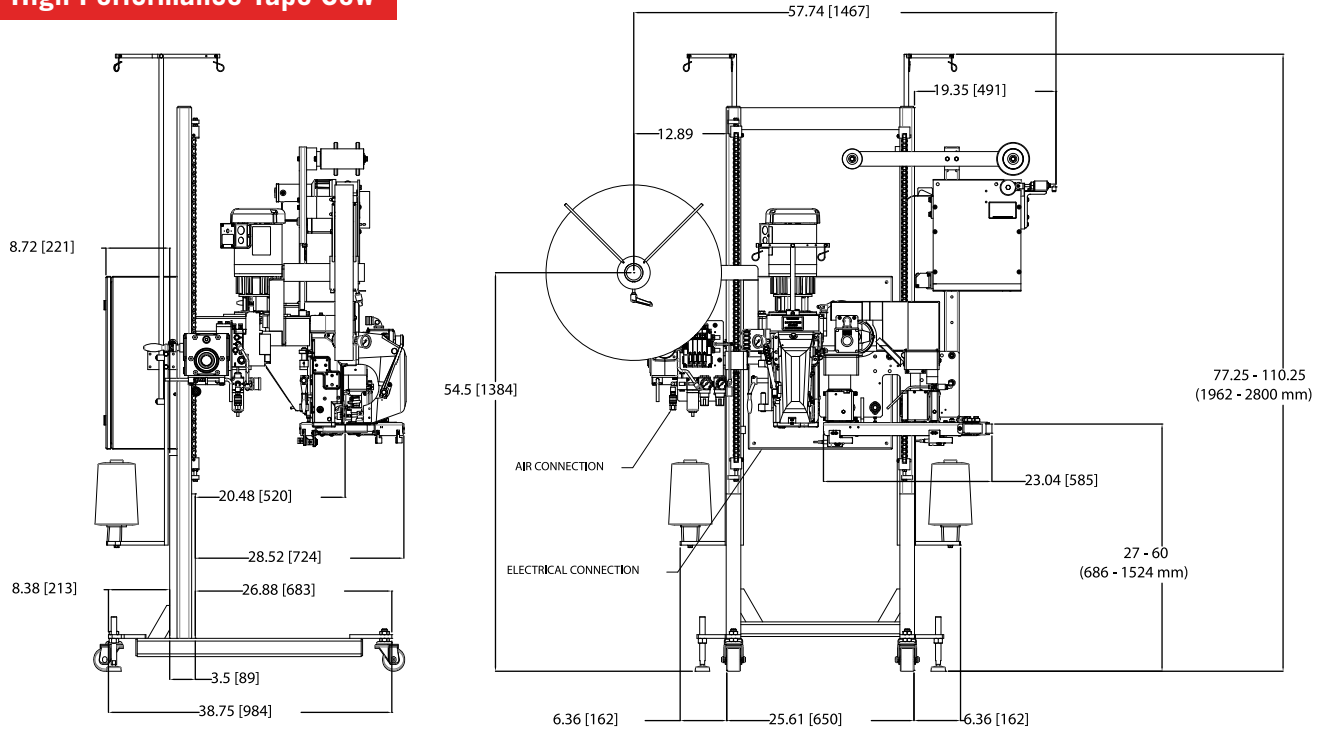

400THPS

FEATURES

BAG TYPES

Closes a variety of bags including flat and gusseted multi-wall paper, and woven polypropylene bags.

EMPRESS 201 SEWING HEAD

With its self-lubricating system, the Empress 201 delivers trouble-free smooth performance with low vibration. Operating speed is adjustable up to 75 linear feet per minute.

BAG TOP TRIMMER

Specifically designed with quick change, long life blades that ensure thousands of hours of trouble-free operation on both paper and laminated woven poly bags.

CREPE TAPE FEED SYSTEM

Tape feed system comes standard and ensures consistent tape feeding over the complete range of speeds.

TAPE CLIPPER

The 400 THP™ comes standard with high performance tape and thread clipper for consistent tape cutting at any speed.

OPTIONS

- Direct drive VFD package for synchronous sewing
- Tape, Thread and Oil Sensor package
- Tape contact coder (P2375)
- Motor starter and contactor for conveyor
- Tagger infeed
- Filler cord
- 575 VAC

SPECIFICATIONS

- Dimensions: L 58 in (147 cm), D 41 in (104 cm), H 78 in (198 cm)
- Speed: Up to 75 linear feet per minute with optional Direct Drive VFD package
- Electric (NEMA 12): 230/380/460 VAC, 3 PH, 50/60 Hz
- Air: 15 cfm @ 90 PSI

BAGS

- Bag Types: Multi-wall paper and laminated
- Bag Thickness: Maximum 12 mils woven polypropylene open mouth bags
- Free Bag Top: Minimum 6 in (15.2 cm)

APPLICATIONS

- Fertilizers/Minerals
- Cat Litter
- Feed Additives
- Bakery Mixes
- Chemicals
- Pet Food
- Agricultural Seed
- Powdered Dairy Products

704-871-1159

**HAMER
FISCHBEIN®**

A DURAVANT COMPANY

Specifications are subject to change without notice.

